

MAXIM 3000™ PORTABLE RESTROOM ASSEMBLY INSTRUCTIONS

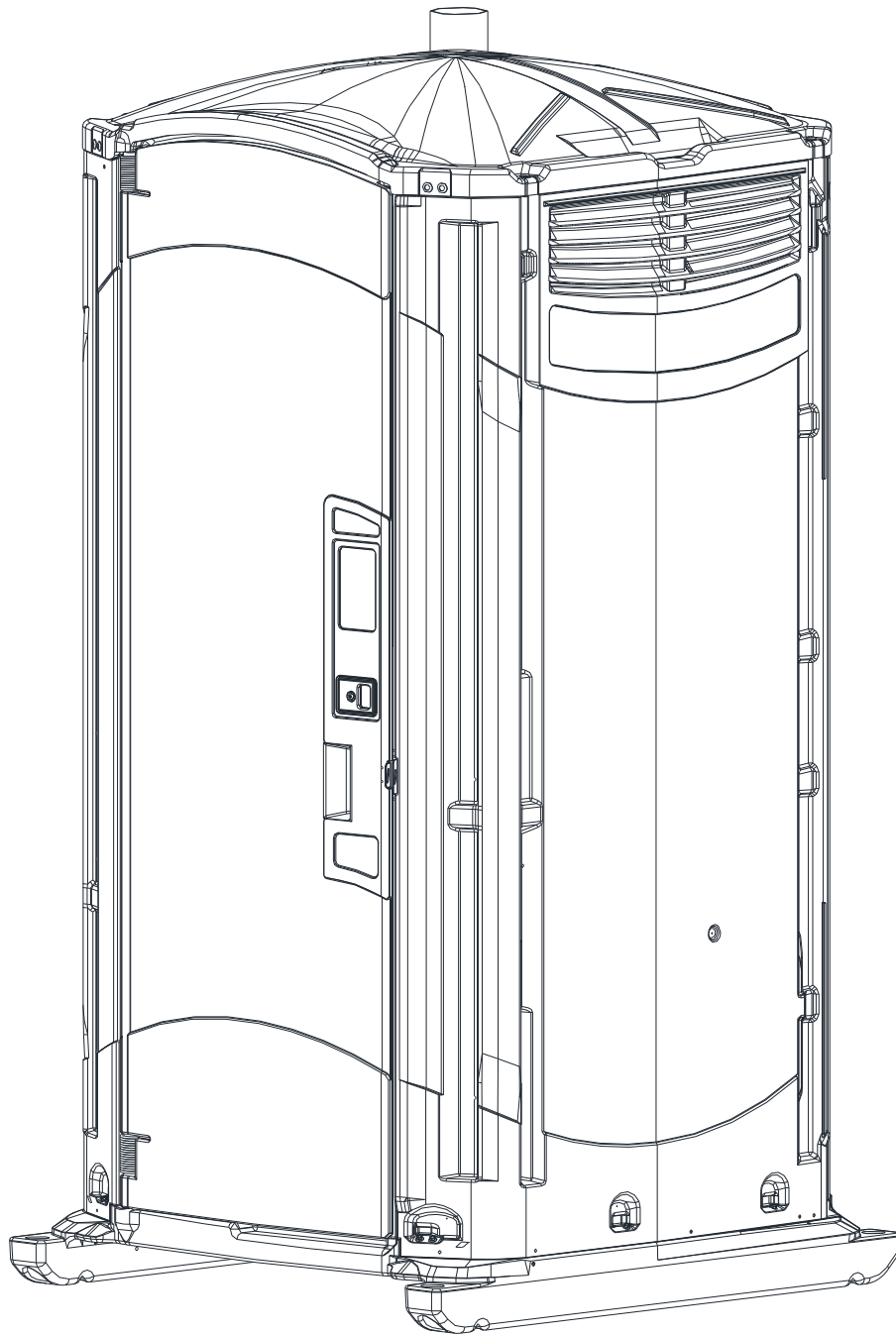

2530 Xenium Lane North, Minneapolis, MN 55441
Telephone: 763-553-1900 Fax: 763-553-1905
www.satelliteindustries.com

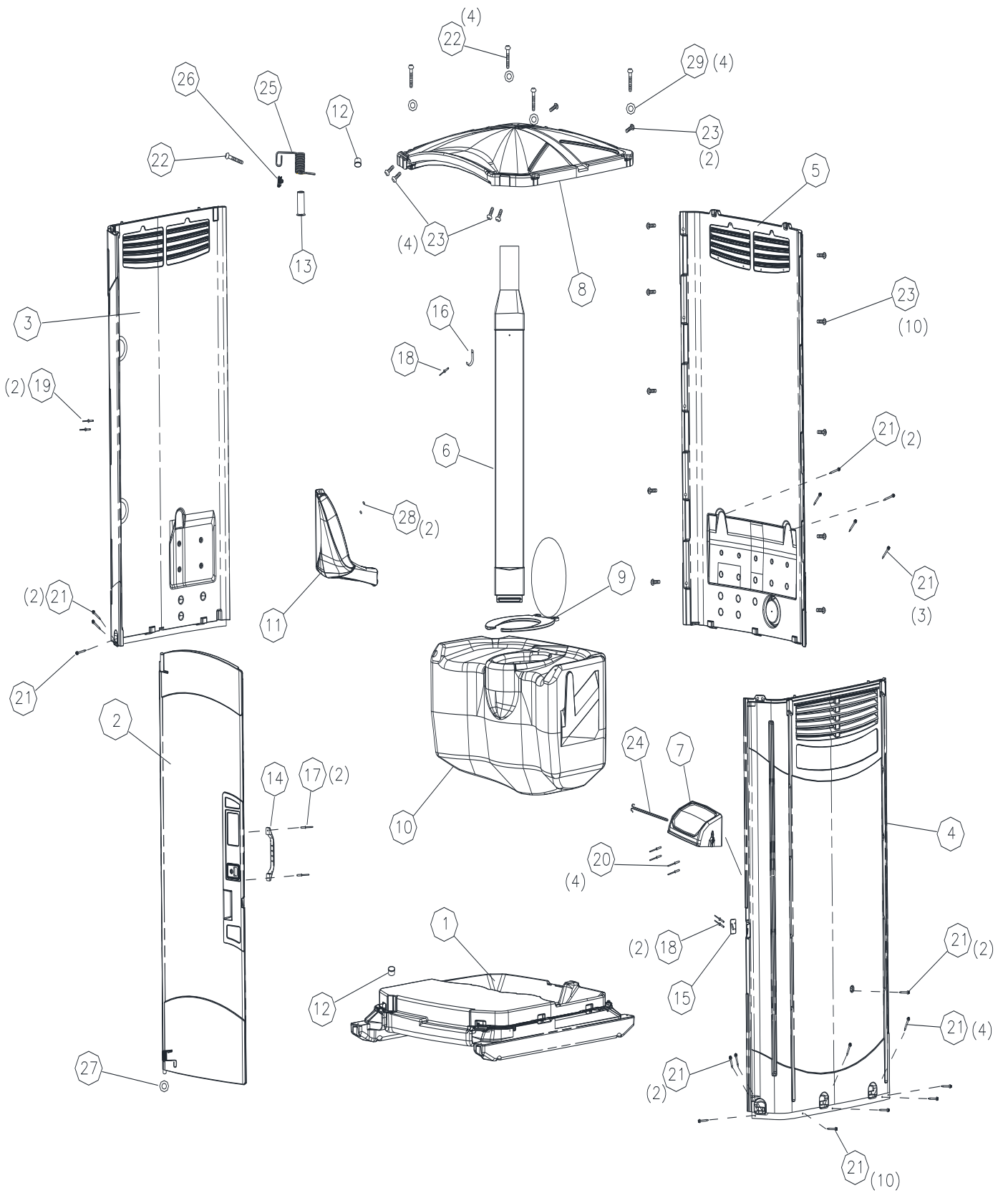

Parts List

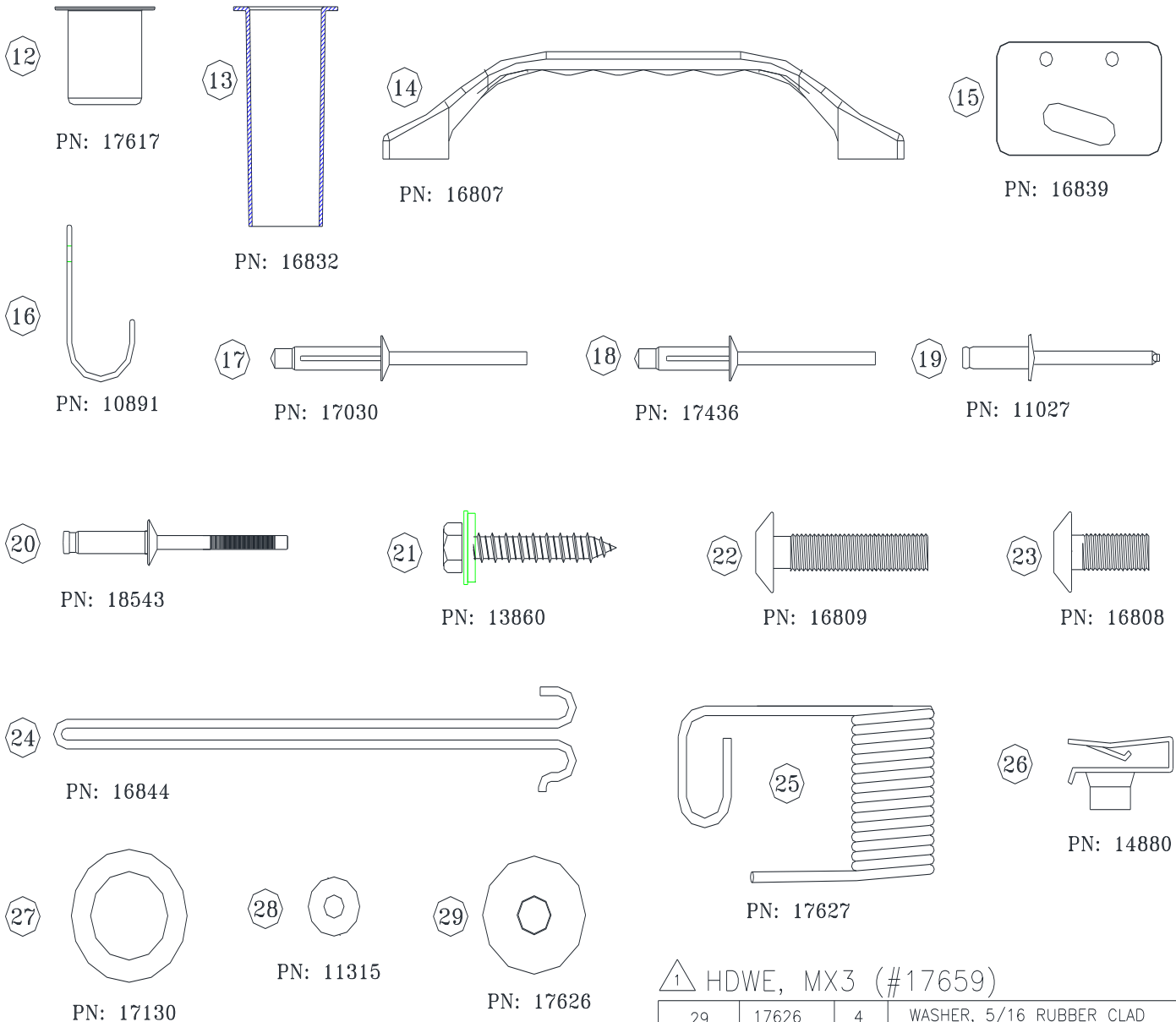

△ HDWE, MX3 (#17659)

STANDARD MX3 ROTOMOLDED BASE

11	16794	1	URINAL, MX3 DGRY
10	16690	1	TANK, MX3 DGRY
9	14959	1	SEAT, ELONGATED BLACK
8	19049	1	ROOF, MX3 ROUND VENT PIPE HOLE
7	17082	1	HOOD, PAPERGUARD 2 ROLL DGRY
	17659	1	HDWE, MX3A
6	19057	1	DESIGN, MX3B VENT PIPE
5	17583	1	DESIGN, MX3A RR PANEL ASSY
4	17585	1	DESIGN, MX3 RT PANEL ASSY
3	17581	1	DESIGN, MX3 LF PANEL ASSY
2	17579	1	DESIGN, MX3A DOOR ASSY
1	19015	1	BASE, MX3 ROTOMOLDED DGRY

29	17626	4	WASHER, 5/16 RUBBER CLAD
28	11315	2	WASHER, 3/16 RIVET STNLS
27	17130	1	WASHER, 1in I.D. NYLON
26	14880	1	U-NUT, 5/16-18
25	17627	1	SPRING, MX3A DOOR UPPER
24	16844	1	SPINDLE, PAPERGUARD 2 ROLL METAL
23	16808	16	SCREW, 5/16-18 X 3/4 TORX
22	16809	5	SCREW, 5/16-18 X 1-1/2 TORX
21	13860	26	SCREW, #14 X 1-1/2 W/WSH GOLD
20	18543	4	RIVET, 3/16 T PEEL
19	11027	2	RIVET, #66 ALUM
18	17436	3	RIVET, AVDEL SILVER
17	17030	2	RIVET, AVDEL BLACK
16	10891	1	HOOK, FLAT COAT STNLS
15	16839	1	HASP, FLAT 2-1/2in LONG
14	16807	1	HANDLE, PLASTIC HOVER
13	16832	1	BUSHING, MX3 DOOR SPRING DGRY
12	17617	2	BUSHING, MX3 DOOR 1.25 DGRY

INTRODUCTION

Satellite portable restrooms must be assembled according to approved assembly procedures. Avoid variations in assembly procedures which could adversely affect product life and warranty.

TOOLS:

- | | | |
|---------------------------------|---|---------------------------------|
| • Standard screwdriver | • Cordless or Drill | • Pliers |
| • Torx bit T-30 | • Pop Rivet Gun | • Nut Driver |
| • 3/8"[9.53] Hex Nut Driver Bit | • #10 (0.194) [5mm] Drill Bit With Drill Stop | • 1 1/32"(0.344)[9mm] Drill bit |

HELPFUL HINTS:

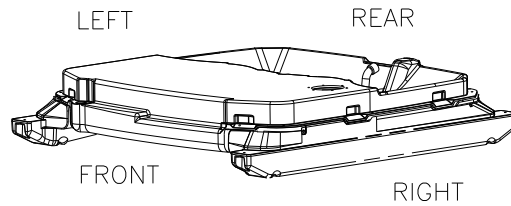

- Keep panels out of direct sunlight.
- Don't open up all of your kit boxes. Open up only enough kit boxes to assemble the number of toilets you are currently working on. **KEEP PARTS ORGANIZED.**
- Staging parts will minimize assembly time.
- Keep driver as upright as possible when driving lag screws for panel to base attachment.

All references to left, right, front and





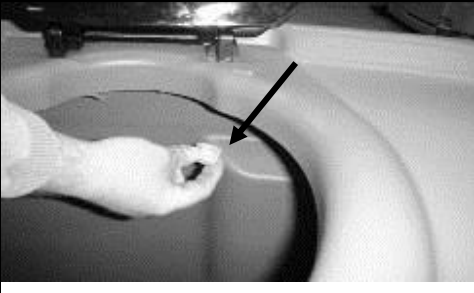

rear correspond to this illustration.

Seat lid assembly.

Position the tank in the base as shown.	Place the toilet seat on the tank and insert the screws through the seat hinges and tank.	Attach the plastic nut to the screws and tighten.
		

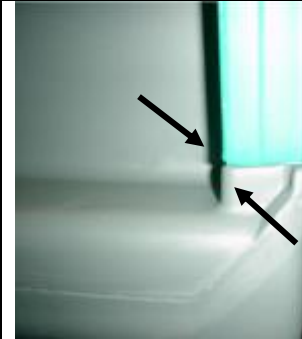
Note: When installing all lag screws with rubber clad washers. Tighten Only until rubber washers begin to flatten (take care not to strip-out screws). Install all lag screws perpendicular to the surface they are going into!

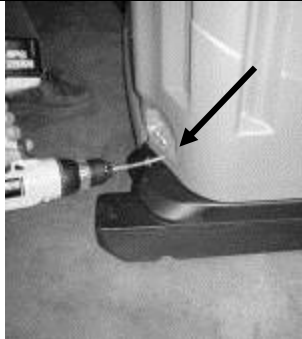
Installing the right/left panels on 3 pc base assembly or Rotomold base.

Install panel flush with base and at this edge before fastening together with lag screws. (Note: very important for either style base)	Push panel firmly against the base with foot and install (2) lag screws PN 13860 vertically into the holes in the front pocket panel into dimples in <u>3 pc base assembly</u> . On <u>rotomold base</u> insert (2) lags screw PN 13860 through holes in panel & into cored holes in base.	Install (1) lag screw PN 13860 horizontally into the dimple just below the front pocket. Repeat step for both left & right panels.	Position the rear panel so that it is centered on Base, as shown.
			

Install Rear panel on 3 pc base assembly or Rotomold base.

Install screw in the bottom pocket of the rear panel (center pocket). Use 5/16" x 3/4" screw PN 16808 (included in kit PN 19066) on 3 pc base assembly into u-nut in base with Torx driver. Use #14 x 1-1/2" lag screw PN 13860 with 3/8"[9.53] hex driver in rotomold base into cored hole in base.

Install (2) screws PN 16808 (included in kit PN 19066) in bottom 2 outside pocket holes in rear panel into 3 pc base assembly u-nut with Torx driver. Install (2) screws PN 13860 in bottom 2 outside pocket holes in rear panel, into 2 cored holes of the rotomold base.

Install the center screw PN 16808 (3rd from the top) from rear into both side panel clips using the Torx bit in the driver.

Finish installing screws PN 16808 from the bottom up on the left panel. Squeeze the panels together when fastening. Repeat for right panel.

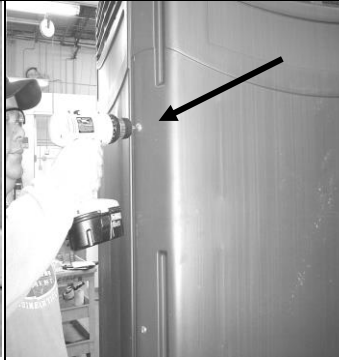
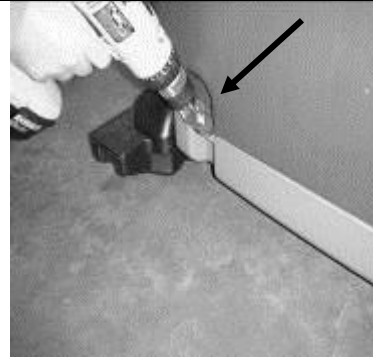
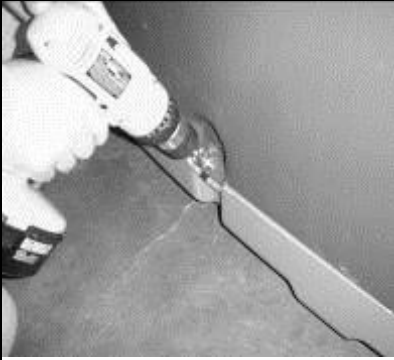

Finish installing the right/left panels.

Push panel firmly against the base with foot and install (2) screws PN 13860 vertically in holes in panel pocket into dimples 3 pc base assembly or through holes in panel to cored holes in rotomold base middle & rear pockets.

Install (1) lag screw PN 13860 horizontally into the dimple below the vertical corner finger groove.

Install (1) lag screw PN 13860 horizontally in the middle of panel 6-1/2" to rear of pocket using the dimples for location.

Install the last (2) lag screws PN 13860 horizontally into the bottom panel using the dimples closest to the rear of the panel.

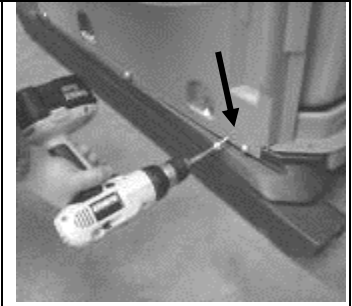

Install vent pipe

Install the vent pipe by pushing down on the vent pipe until it seats in the tank.

Assemble roof.

Position the roof over the panels and vent pipe.

Pull the roof down over the vent pipe from the outside.

Hold the Roof flush to Panel while fastening together. Install (2) 3/4" screws PN 16808 horizontally in the front right side of the roof .

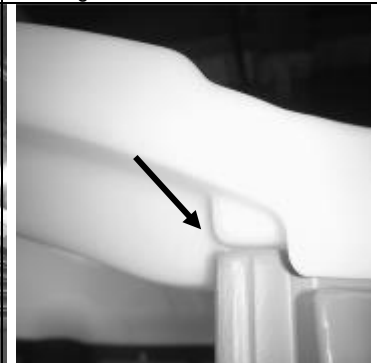

Finish roof.

Install (2) 3/4" screws PN 16808 horizontally in the rear of the roof (as shown).



Install (3) 1-1/2" long screws PN 16809 with 5/16" rubber clad washers (3) PN 17626 in the rear corners & in the front right corner.

**Install the coat hook.**

Drill a hole in the vent pipe using the dimple for location.



Using a silver colored expanding rivet PN 17436, attach the coat hook to the vent pipe.

**Install the urinal.**

Drill dimple with #10 drill bit



Place the drain tube of the urinal into the hole in the tank

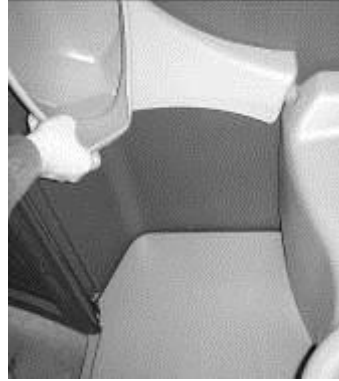

Insert rivet into the urinal and panel to hold its position while drilling the other hole.

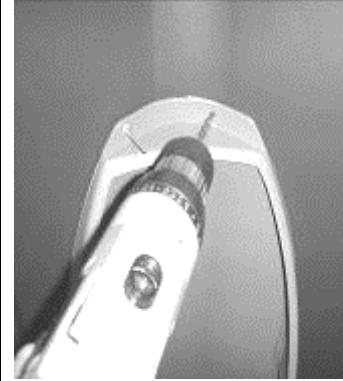

While one person holds the urinal in place insert rivets PN 11027 through the panel from the outside and into the urinal. Place 3/16" backup washers PN 11315 on the inside and set rivets.

**Install the hasp.**

Using a #10 (0.194") drill bit, drill the two dimples in the right panel.

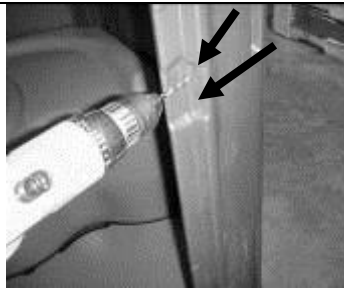

Rivet the hasp PN 16839 to the panel using two silver expanding rivets PN 17436. Note: position the slot in the hasp as shown.

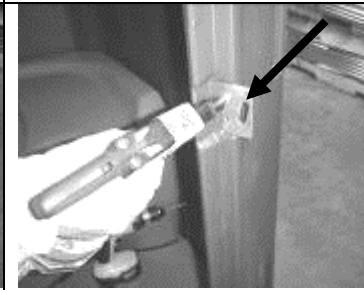
**Install the paper guard.**

The paper guard can be installed in two locations: the Right panel in Straight drop units or Left panel for units with Handwash Stations or Swish Tanks.







Note: When installing with Swish Tank, position paperguard bottom 2" above the top two dimples, mark and drill using holes in paperguard and rivet.

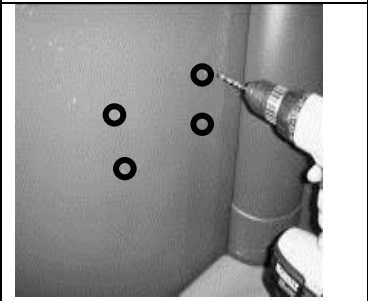
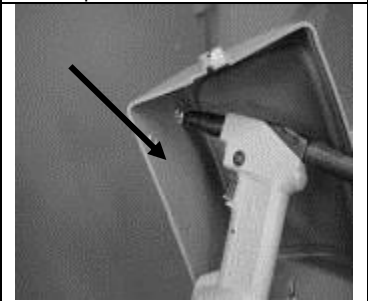
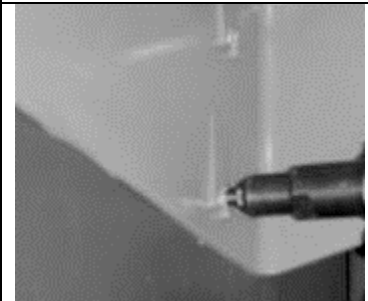
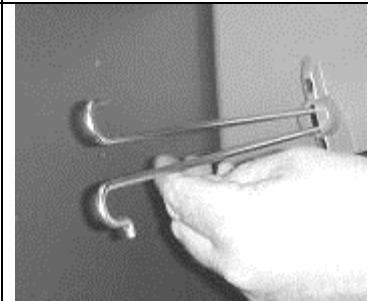

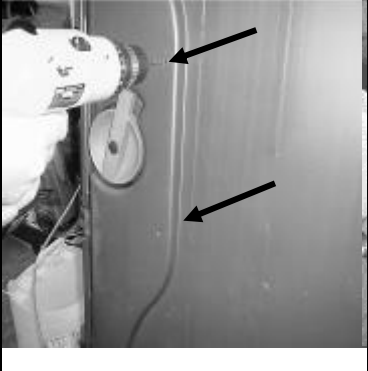

Finish paperguard installation.

<p>Drill the four dimples shown for the paperguard using a #10 (0.194") drill bit. (use drill stop to prevent drilling through outside wall.)</p>	<p>Insert 3/16" T Rivets PN 18543 through the top most hole in the paperguard PN 17082. Place paperguard and rivet in matching hole in panel.</p>	<p>Rivet the other top hole in the paperguard. Rivet the two lower holes in the paperguard to the panel using two more 3/16" T rivet.</p>	<p>Insert the spindle PN 16844 into the paperguard. Note: position the hook as shown.</p>
			

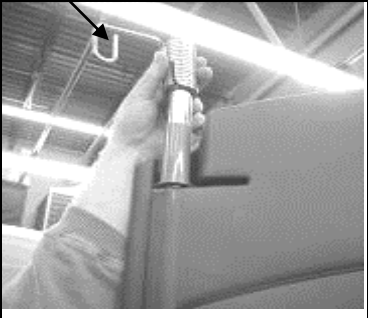

Start door assembly.

<p>Drill the (2) dimples near the latch using a #10 (0.194") drill bit. (if not already drilled)</p>	<p>Rivet the door handle PN 16807 to the door using (2) Avdel black rivets PN 17030.</p>	<p>Insert the short grey bushing PN 17617 into the pivot pocket in the base.</p>	<p>Install Gray Bushing PN 17617 into roof pivot hole.</p>
			

Door assembly.

<p>Place the long bushing PN 16832 (with the flange down) over the tube at the top of the door.</p>	<p>Place upper door spring PN 17627 over the long bushing. Note the position of the loop on the spring.</p>	<p>Bend the upper leg of the spring behind the door and slide the spring downwards. CAUTION: the spring may slip and hit your hand.</p>	<p>Installed spring viewed from the inside of the door.</p>
			

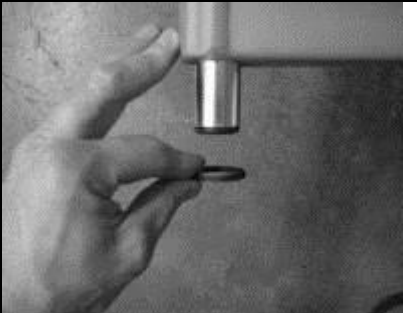
Finish the door assembly.

<p>Install the black plastic washer PN 17130 on the bottom of the door tube.</p>	<p>Drill 11/32" (0.344) hole at dimple through panel for spring arm u-nut.</p>	<p>Install u-nut PN 14880 onto bottom of spring arm loop. (Note: when spring arm is back under roof the barrel of the u-nut to be toward rear of unit.)</p>
		

Install the Door.

Insert the door tube into the short bushing installed in the base. Bottom spring will sit on base. (Make sure black washer is on door tube).

Insert bottom spring arm between facing and base. Push down with your foot into space between panel and the base.

Lift the roof up, pull the door into position and pull the roof down over the door tube.

Push spring arm up until it contacts inside of roof in groove, where panel sits. Pull down on roof to trap spring arm. (Be very careful the spring arm doesn't slip and hit your hand.)

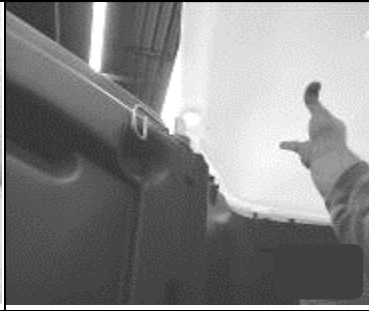
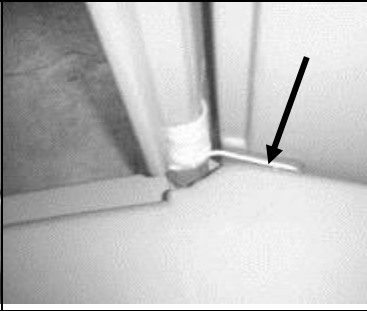
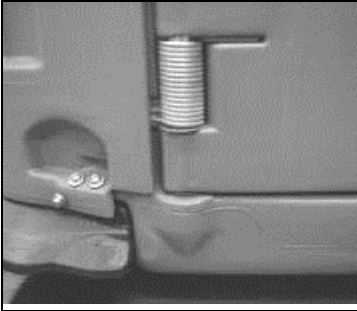

Finish roof and door installation.

Install 1-1/2" long screw PN 16809 with 5/16" rubber clad washer PN 17626 in front left corner of roof.

Pull down on the roof as shown and install (2) 3/4" screws PN 16808 in front left corner of roof.

Install 1-1/2" long screw PN 16809 from outside through hole in panel and into u-nut on spring arm. You will need a person inside with a Pliers to hold u-nut.

Tighten bolt only until spring arm is approximately 1/8" from panel surface.

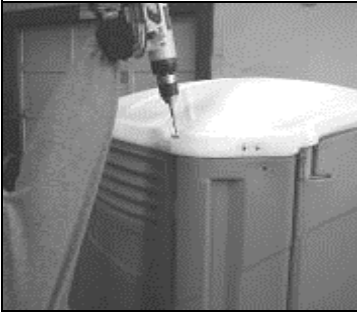

Install the tank.

To properly seat the tank, have someone stand in it as shown. This person should signal when the screws have tightened the panel to the tank.

Install (2) lag screws PN 13860 in the rear panel. Use the recesses and dimples for the locations. Note: Do back screws first!

Install a lag screw PN 13860 in the left panel. Use the recess and dimples for the locations.

If installing the Maxim 3000 Handwash, do so before installing the right side lag screw.

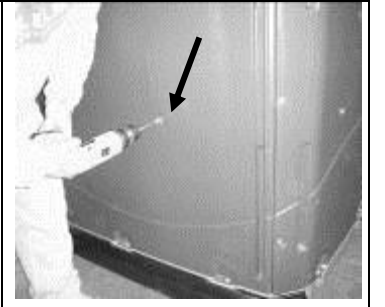
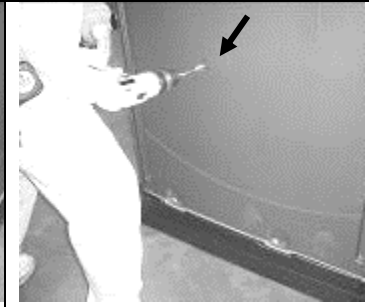

Install screw to hold bottom spring arm between base & panel.

Screw location: front bottom pocket of left panel dimple on small raised pad shown below.

Prior to screw installation make sure arm of lower door spring down between base & panel. End of arm is 1/4" to 1/2" below floor level.

Install screw PN 13860 at location on raised pad front pocket left panel (through panel into base trapping spring arm between panel & base).

